





# Index

About Us	4
Furniture - Wall Shelves	6
Furniture - Bookcases	18
Bathroom Products	42
Laundry Drying Racks	50



# About Us



## **DYNAMIC TEAM**

We are a dynamic team headquartered in Izmir/Turkey, with branch offices in Los Angeles and in London. Our mission is offer modern, high-quality products that will improve our customers' quality of life.

## **FULLY INTEGRATED MANUFACTURING**

From the design of new products to state-of-the-art laser cutting and powder coating lines, we manufacture our products in a fully integrated facility. Our plant is strategically located in close proximity to Port of Aliaga to maximize our distribution efficiency worldwide.

## **COMMITMENT TO EXCELLENCE**

We are committed to 100% customer satisfaction:

- Every product is designed with the best craftsmanship.
- We only use highest quality materials to maximize durability.
- From delivery to customer support, we stand behind our products.



## Furniture

- Wall Shelves

# Lisbon 3-Tier Contemporary Wall Shelf

E-Commerce Ready	Optimized for online shipments with corrugated honeycomb pads for maximum protection.
Warranty	No-questions asked replacement guarantee for a year.
Material	18 mm particle board

**Color Options** Talk to your sales representative for additional color options.

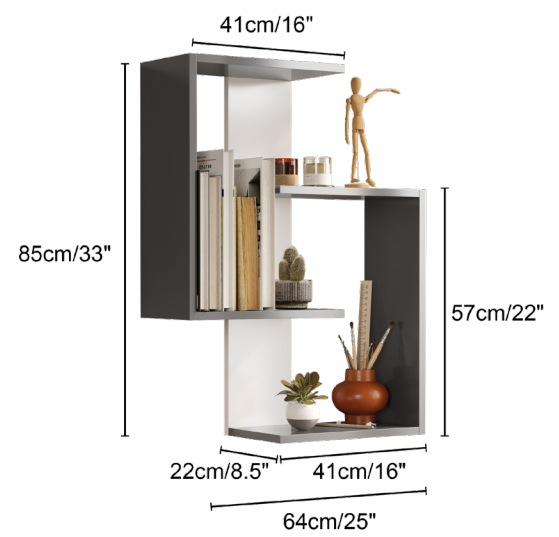

- Sturdy Design**
- Elegant & Contemporary**
- Practical**
- Easy To Install**





# Capri Modular Wall Shelf - Single or 2-Pack

E-Commerce Ready	Optimized for online shipments with corrugated honeycomb pads for maximum protection.
Warranty	No-questions asked replacement guarantee for a year.
Material	18 mm particle board.

**Color Options** Talk to your sales representative for additional color options.

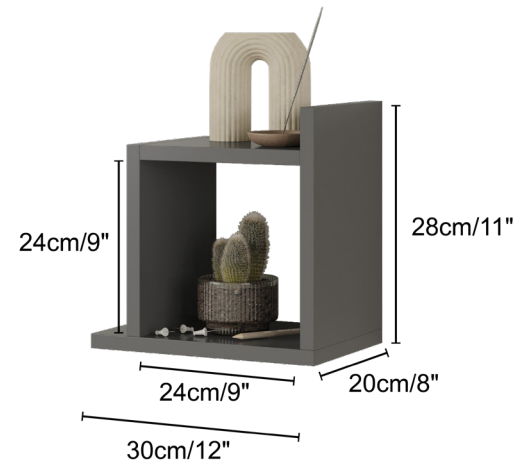

-  **Sturdy Design**
-  **Elegant & Contemporary**
-  **Practical**
-  **Easy To Install**







# Mykonos Contemporary Wall Shelf - 2-Pack

E-Commerce Ready	Optimized for online shipments with corrugated honeycomb pads for maximum protection.
Warranty	No-questions asked replacement guarantee for a year.
Material	18 mm particle board

### Color Options



Talk to your sales representative for additional color options.

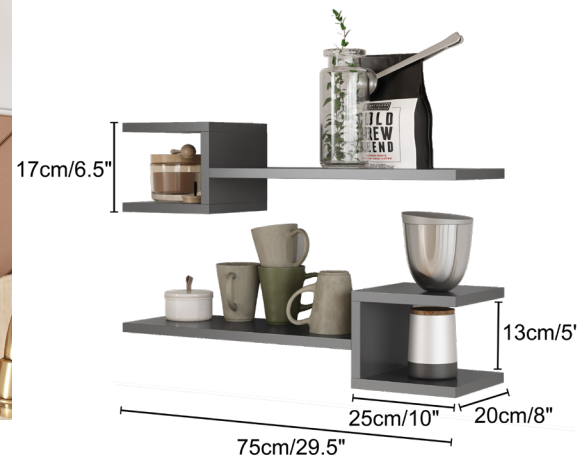

Sturdy Design



Elegant & Contemporary



Practical



Easy To Install





# Genoa Contemporary Wall Shelf

E-Commerce Ready	Optimized for online shipments with corrugated honeycomb pads for maximum protection.
Warranty	No-questions asked replacement guarantee for a year.
Material	18 mm particle board.



Talk to your sales representative for additional color options.



Sturdy Design



Elegant & Contemporary



Practical



Easy To Install





# Furniture

- Bookcases



# Milan 5-Tier Dual-Color Bookcase

E-Commerce Ready	Optimized for online shipments with corrugated honeycomb pads for maximum protection.
Warranty	No-questions asked replacement guarantee for a year
Material	18 mm particle board

Color Options Talk to your sales representative for additional color options.



-  **Sturdy Design**
-  **Elegant & Contemporary**
-  **Practical**
-  **Easy To Install**





# Palermo 6-Tier Dual-Color Bookcase

E-Commerce Ready	Optimized for online shipments with corrugated honeycomb pads for maximum protection.
Warranty	No-questions asked replacement guarantee for a year.
Material	18 mm particle board.



Talk to your sales representative for additional color options.



-  Sturdy Design
-  Elegant & Contemporary
-  Practical
-  Easy To Install







# Granada Modern Labyrinth Bookcase

E-Commerce Ready	Optimized for online shipments with corrugated honeycomb pads for maximum protection.
Warranty	No-questions asked replacement guarantee for a year.
Material	18 mm particle board.

**Color Options**  

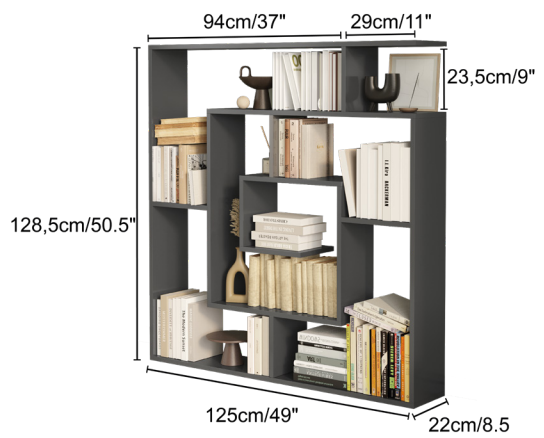
 Talk to your sales representative for additional color options.



-  **Sturdy Design**
-  **Elegant & Contemporary**
-  **Practical**
-  **Easy To Install**



# Monaco 5-Cube Bookcase

E-Commerce Ready	Optimized for online shipments with corrugated honeycomb pads for maximum protection.
Warranty	No-questions asked replacement guarantee for a year.
Material	18 mm particle board.

### Color Options



Talk to your sales representative for additional color options.

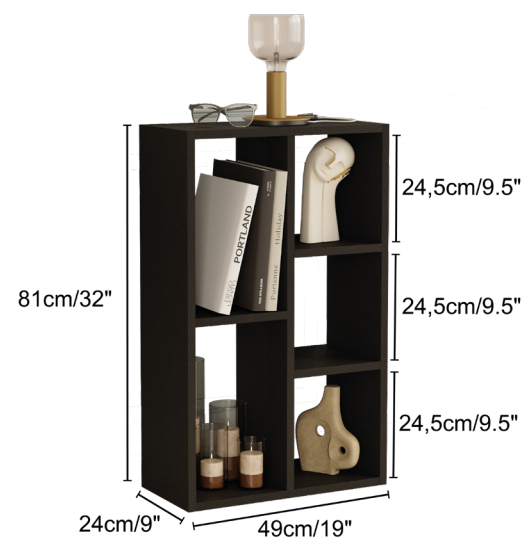

-  **Sturdy Design**
-  **Elegant & Contemporary**
-  **Practical**
-  **Easy To Install**









# Canaria 3-Tier Bookcase

E-Commerce Ready	Optimized for online shipments with corrugated honeycomb pads for maximum protection.
Warranty	No-questions asked replacement guarantee for a year.
Material	18 mm particle board.

### Color Options



Talk to your sales representative for additional color options.



-  Sturdy Design
-  Elegant & Contemporary
-  Practical
-  Easy To Install





# Bristol 8-Cube Bookcase

E-Commerce Ready	Optimized for online shipments with corrugated honeycomb pads for maximum protection.
Warranty	No-questions asked replacement guarantee for a year.
Material	18 mm particle board.

Color Options



Talk to your sales representative for additional color options.



Sturdy Design



Elegant & Contemporary



Practical



Easy To Install







# Santorini 5-Tier Vertical Bookcase

E-Commerce Ready	Optimized for online shipments with corrugated honeycomb pads for maximum protection.
Warranty	No-questions asked replacement guarantee for a year.
Material	18 mm particle board.

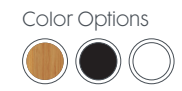

Talk to your sales representative for additional color options.



-  **Sturdy Design**
-  **Elegant & Contemporary**
-  **Practical**
-  **Easy To Install**





# Aruba 6-Cube Horizontal Bookcase

E-Commerce Ready	Optimized for online shipments with corrugated honeycomb pads for maximum protection.
Warranty	No-questions asked replacement guarantee for a year.
Material	18 mm particle board.

**Color Options** Talk to your sales representative for additional color options.

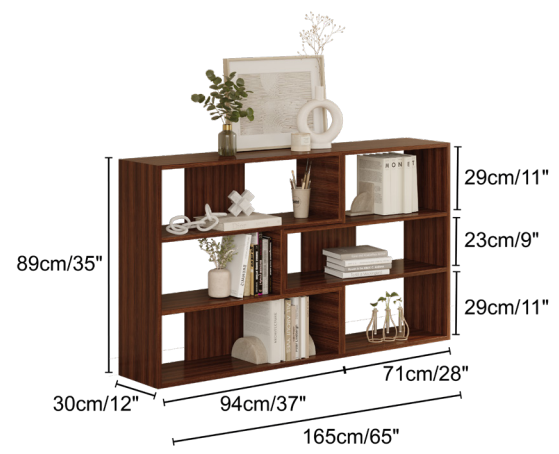

-  **Sturdy Design**
-  **Elegant & Contemporary**
-  **Practical**
-  **Easy To Install**





## Bathroom Products

# Fiji Metal Double Roll Toilet Paper Holder

E-Commerce Ready	Optimized for online shipments with corrugated honeycomb pads for maximum protection.
Warranty	No-questions asked replacement guarantee for a year.
Material	Stainless galvanized metal.

**Color Options**  
 Talk to your sales representative for additional color options.

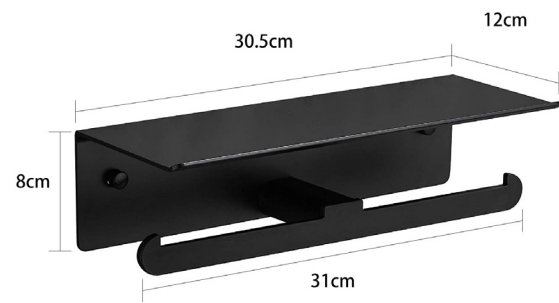

-  Sturdy Design
-  Elegant & Contemporary
-  Practical
-  Easy To Install





## Palawan Metal Towel Rack for Bathroom and Kitchen

E-Commerce Ready	Optimized for online shipments with corrugated honeycomb pads for maximum protection.
Warranty	No-questions asked replacement guarantee for a year.
Material	Stainless galvanized metal.

Color Options



Talk to your sales representative for additional color options.

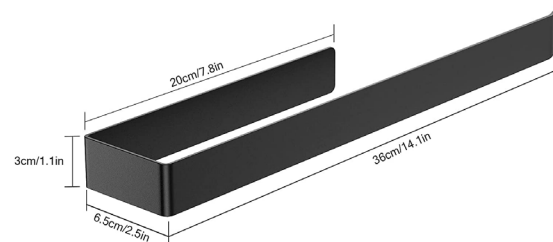

Sturdy Design



Elegant & Contemporary



Practical



Easy To Install







## Boracay Metal Shelf for Shower and Kitchen

E-Commerce Ready	Optimized for online shipments with corrugated honeycomb pads for maximum protection.
Warranty	No-questions asked replacement guarantee for a year.
Material	Stainless galvanized metal.

Color Options



Talk to your sales representative for additional color options.

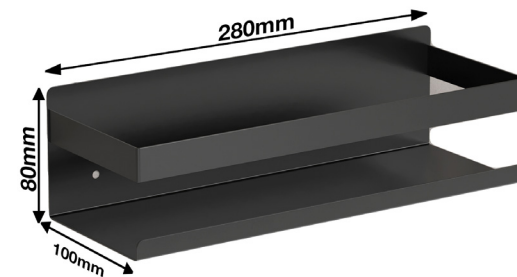

Sturdy Design



Elegant & Contemporary



Practical



Easy To Install





# Laundry Drying Racks



# Belize Wall-Mounted Retractable Laundry Drying Rack

E-Commerce Ready	Optimized for online shipments with corrugated honeycomb pads for maximum protection
Warranty	No-questions asked replacement guarantee for a year
Material	Stainless steel body and aluminum rods

Color Options Talk to your sales representative for additional color options.



Sturdy Design



Elegant & Contemporary



Practical



Easy To Install





**DIMENSIONS & WEIGHT**

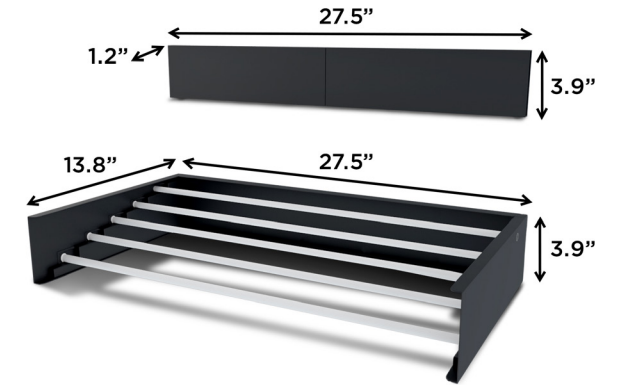

Weight of the rack: 5 lbs

**DIMENSIONS & WEIGHT**

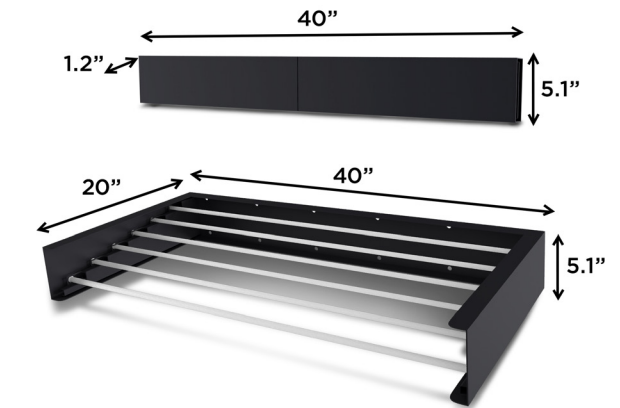

Weight of the rack: 9 lbs



Kazım Karabekir Mah. 6909/1. Sk.  
No:4/3 35865 Torbalı/İzmir



+90 232 225 50 50



[www.unidecohome.com](http://www.unidecohome.com)

